

**FEATURES**

- ✘ Vertical and right angle types
- ✘ Miniature size with stainless steel cover
- ✘ Low profile (3.0mm)

**APPLICATION**

- ✘ Instrumentation
- ✘ Industrial automation
- ✘ Building & Home automation

**SPECIFICATION**

Contact Rating	25mA, 24V DC
Contact Resistance	100mΩ max.
Insulation Resistance	100MΩ min. 100V DC
Dielectric Strength	250V AC/1 minute
Operating Force	200gf-cm max.
Operating Life	10, 000 Steps
Operating Temp.	-30°C ~ +80°C
Storage Temp.	-40°C ~ +85°C

**HOW TO ORDER**

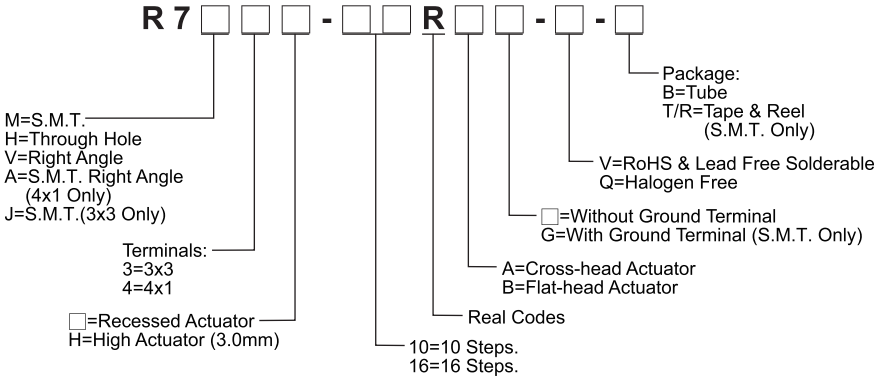

**PACKAGE**

- <Tube>  
R7H, R7M: 63 pcs  
R7V: 60 pcs
- <Tape & Reel>  
R7M\*: 1450 pcs  
R7M\*H: 850 pcs  
R7A: 750 pcs  
R7A4H: 750 pcs  
R7J: 1450 pcs

ROTARY CODED SWITCH

**R7M3-10RAG**

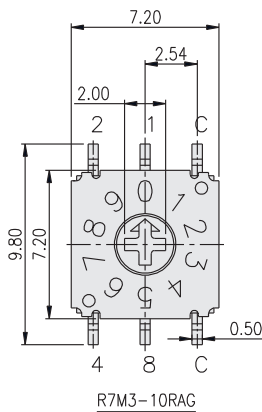

R7M3-10RAG

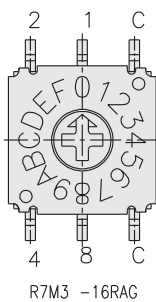

R7M3-16RAG

TYPE	POSITION	CODE			
		1	2	4	8
10R	0	●	●	●	●
	1	○	●	●	●
	2	●	○	●	●
	3	○	○	●	●
	4	●	●	○	●
	5	○	●	○	●
	6	●	○	○	●
	7	○	○	○	●
	8	●	●	●	○
	9	○	○	●	○
16R	A	○	○	●	○
	B	○	○	●	○
	C	●	●	○	○
	D	○	●	○	○
	E	●	○	○	○
	F	○	○	○	○

PART NO.	H
R7M3-10RAG	0
R7M3-16RAG	0
R7M3H-10RAG	3.00
R7M3H-16RAG	3.00

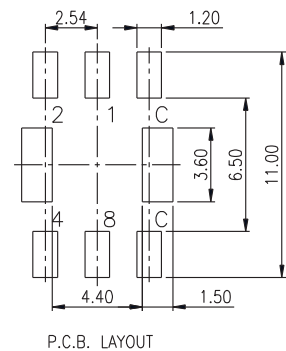

P.C.B. LAYOUT

**R7H3**

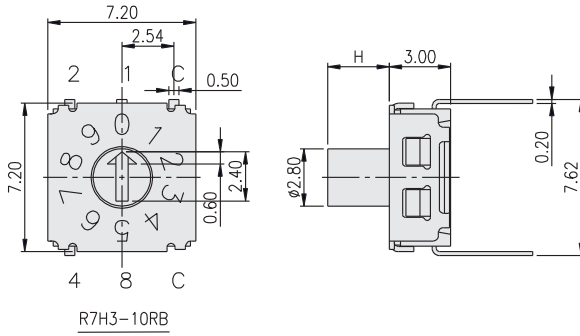

R7H3-10RB

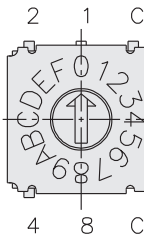

R7H3-16RB

TYPE	POSITION	CODE			
		1	2	4	8
10R	0	●	●	●	●
	1	○	●	●	●
	2	●	○	●	●
	3	○	○	●	●
	4	●	●	○	●
	5	○	●	○	●
	6	●	○	○	●
	7	○	○	○	●
	8	●	●	●	○
	9	○	○	○	○
16R	A	●	○	●	○
	B	○	○	●	○
	C	●	●	○	○
	D	○	●	○	○
	E	●	○	○	○
	F	○	○	○	○

PART NO.	H
R7H3-10RB	0
R7H3-16RB	0
R7H3H-10RB	3.00
R7H3H-16RB	3.00

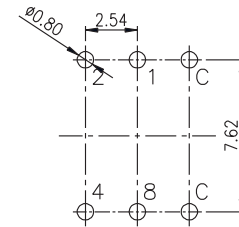

P.C.B. LAYOUT

ROTARY CODED SWITCH

**R7A4**

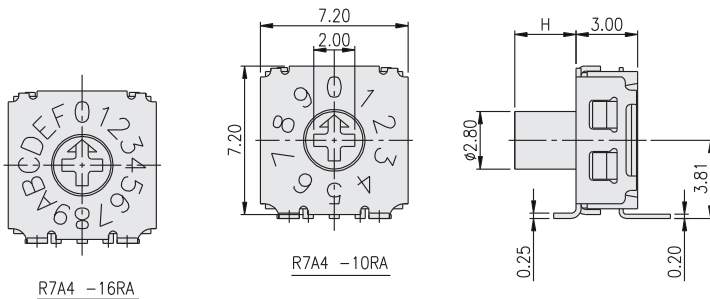

R7A4-16RA

R7A4-10RA

TYPE	POSITION	CODE			
		1	2	4	8
10R	0	●	●	●	●
	1	○	●	●	●
	2	●	○	●	●
	3	○	○	●	●
	4	●	●	○	●
	5	○	●	○	●
	6	●	○	○	●
	7	○	○	○	●
	8	●	●	●	○
	9	○	○	○	○
16R	A	●	○	●	○
	B	○	○	●	○
	C	●	●	○	○
	D	○	●	○	○
	E	●	○	○	○
	F	○	○	○	○

PART NO.	H
R7A4-10RA	0
R7A4-16RA	0
R7A4H-10RA	3.00
R7A4H-16RA	3.00

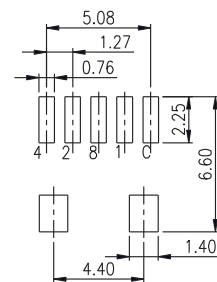
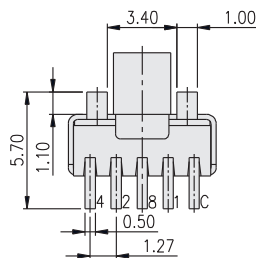

P.C.B. LAYOUT

**R7V3**

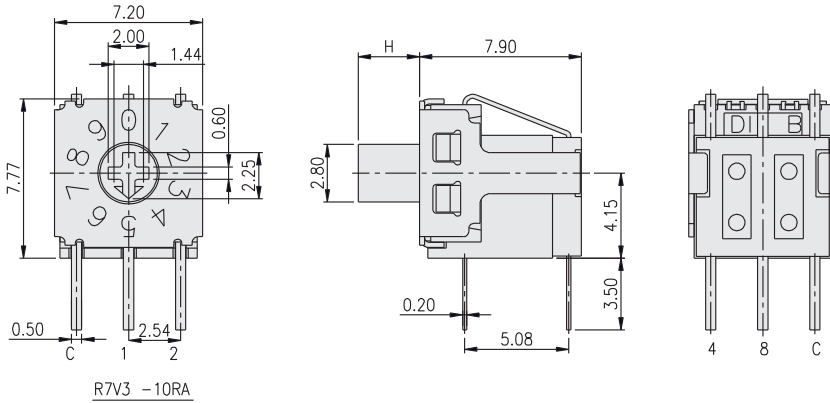

R7V3 -10RA

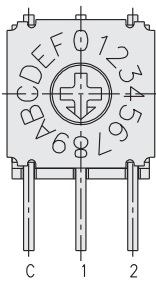

R7V3 -16RA

PART NO.	H
R7V3-10RA	0
R7V3-16RA	0
R7V3H-10RA	3.00
R7V3H-16RA	3.00

		CODE			
TYPE	POSITION	1	2	4	8
		10R	0	●	●
	1	○	●	●	●
	2	●	○	●	●
	3	○	○	●	●
	4	●	●	○	●
	5	○	●	○	●
	6	●	○	○	●
	7	○	○	○	●
	8	●	●	●	○
	9	○	○	●	○
16R	A	●	○	●	○
	B	○	○	●	○
	C	●	●	○	○
	D	○	●	○	○
	E	●	○	○	○
	F	○	○	○	○

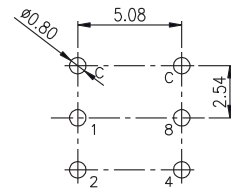

P.C.B. LAYOUT

ROTARY CODED SWITCH

**R7J3**

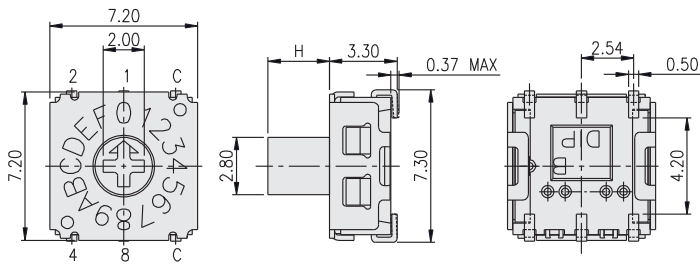

R7J3-16RA

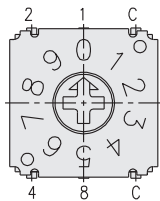

R7J3-10RA

PART NO.	H
R7J3-10RA	0
R7J3-16RA	0
R7J3H-10RA	3.00
R7J3H-16RA	3.00

		CODE			
TYPE	POSITION	1	2	4	8
		10R	0	●	●
	1	○	●	●	●
	2	●	○	●	●
	3	○	○	●	●
	4	●	●	○	●
	5	○	●	○	●
	6	●	○	○	●
	7	○	○	○	●
	8	●	●	●	○
	9	○	○	●	○
16R	A	●	○	●	○
	B	○	○	●	○
	C	●	●	○	○
	D	○	●	○	○
	E	●	○	○	○
	F	○	○	○	○

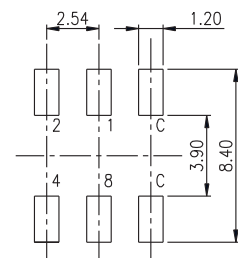

P.C.B. LAYOUT